

SPAR-Logistics handbook for suppliers - Slow moving warehouse for fresh goods

**Assortment: Processed Meat, Cheese and Dairy
Products**

Version: May 2023

History of changes

Version	Changes	Page
May 2023	Adjustment of amount billed	Page 19
May 2023	Adjustment of amount billed	Page 23

Table of Contents:

1. [New Suppliers](#)
2. [Delivery Process in all SPAR Warehouses](#)
 - [2.1 Details central Warehouse - Vorchdorf](#)
3. [Conditions for Delivery Processing](#)
 - [3.1 Loading Aids](#)
 - [3.2 Pallet Quality](#)
 - [3.3 Pallet Goods-Shifting](#)
 - [3.4 Pallet Heights](#)
 - [3.5 Pallet Weight](#)
 - [3.6 Condition of the pallet](#)
 - [3.7 Delivery in Reuseable Cases](#)
 - [3.8 Condition of the picking unit](#)
 - [3.9 Delivery note](#)
4. [Labelling](#)
 - [4.1 Pallet Labeling](#)
 - [4.2 Examples of Delivery Notes \(DIN A5\)](#)
 - [4.3 Placement of the pallet labels](#)
 - [4.4 Product Labelling](#)
 - [4.5 RPU \(Retail Packaging Unit\)](#)
 - [4.6 Barcode quality](#)
5. [Electronic Data Interchange with SPAR](#)
6. [Safety measurements at Goods Receiving](#)

1. New Suppliers

- In order to avoid any problems in advance, please contact the Logistics Department prior to the first delivery.
- Contact:
 - SPAR Österr. Warenhandels AG, Salzburg, Europastr. 3, A-5015 Salzburg:
 - Fabian Eßl, BA
 - Tel.: +43 664 8874 8668
 - E-Mail: fabian.essl@spar.at
 - Mag. Matthias Kienzl
 - Tel.: +43 664 8159 189
 - E-Mail: matthias.kienzl@spar.at
- Additionally, the registration on our B2B Portal is necessary (<http://b2b.spar.at>). There you also always find the latest version of our logistics handbook.

Delivery Process in all SPAR Warehouses

Goods Arrival:

The goods arrival can occur by truck in all SPAR Warehouses. The goods arrival by bus, car or any other small vehicle is not allowed and will lead to a rejection of the delivery.

Standard Delivery Condition for all regional Warehouses:

Delivery by truck behind first free lockable door or if existing onto the free conveyor equipment (Furthermore the SPAR Company general terms of delivery apply). For the unloading of the goods the suppliers will be supplied with manual pallet lifters, electrical pallet lifters and double-pallet fork-lift trucks.

Punctuality of Deliveries:

All delivery dates, which are agreed with SPAR, must be met. Trucks, which arrive on the wrong date, can be rejected by the goods arrival. If a delivery is made after the agreed delivery time window, the additional expense incurred will be charged at EUR 10 per pallet.



2.1 Details Central-Warehouse Vorchdorf (ZLF)

SPAR Zentrallager Frische

Delivery Area	Austria
Address	Feldhamer Straße 2, 4655 Vorchdorf
GLN	9100300007301
Acronym	ZLF

Contact Information

Name	Phone-Number	E-Mail
Georg Kampenhuber	+43 664 78360336	Georg.Kampenhuber@spar.at

Incoming Goods – Arrival Times

Monday	00:00-04:00 O'clock
Monday-Wednesday	20:00-24:00 O'clock
Thursday	Closed
Friday	20:00-24:00 O'clock
Saturday-Sunday	Closed

Conditions for Delivery Processing

Classification of articles

SPAR will provide you with the classification of your items prior to the first delivery. The following aspects need to be considered:

- **Picking-Articles:**
 - Ordering of picking items is done directly by the dispatcher of the central warehouse.
 - All quantities must be delivered bundled on their own pallets per item.
 - One delivery note required for all picking-Articles.
- **Transshipment-Articles:**
 - Transshipment articles are ordered by the dispatchers of the regional distribution center.
 - One delivery of the articles is made on one pallet per branch incl. required pallet labeling.
 - If several items are classified as Transshipment-Articles, they must be kept together on the truck for each Order-Number/Distribution-Center.

Delivery of Transshipment-Articles

- Transshipment-Articles must be kept together per warehouse upon delivery.
- The delivery papers must be issued per warehouse and must be on the pallet stack.
- **The warehouse and the SPAR order number of the order must be printed on the pallet label.**

If the quality of the delivery does not meet the requirements, SPAR reserves the right to charge the additional expenses of EUR 20,- per pallet.

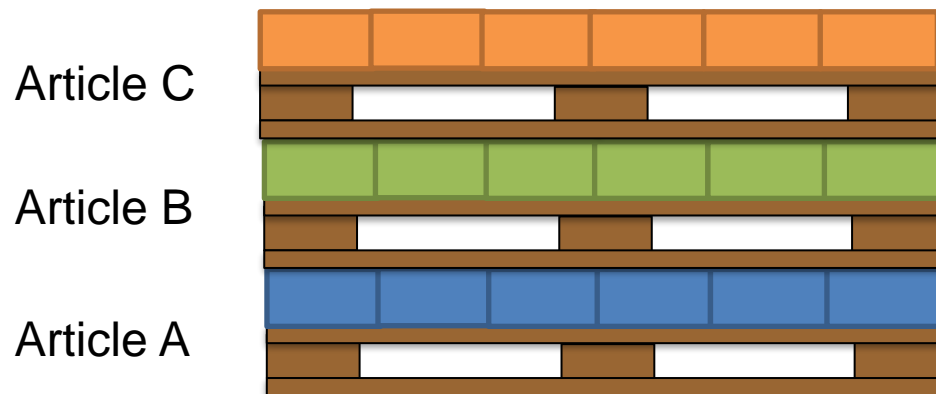

Stacking of Pallets on the truck based on.

For example: Marchtrenk

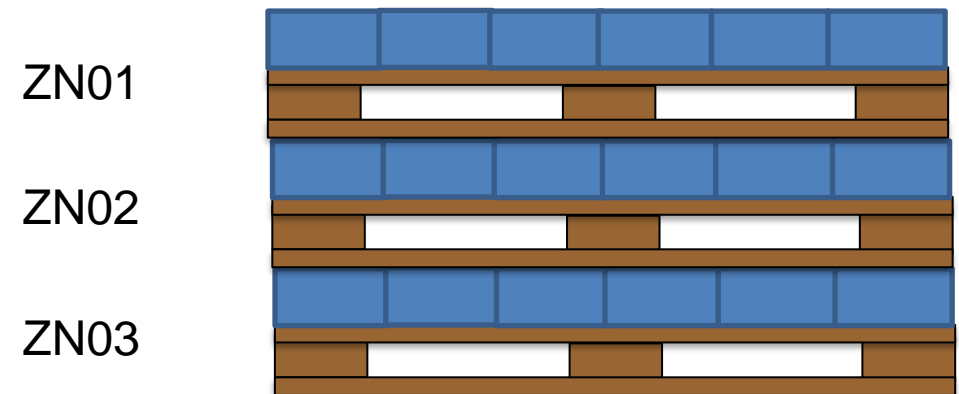



Stacking of Pallets on the truck based on article



3.1 Loading Aids

Accepted Loading Aids:

IFCO-Palette (B1208A)	CHEP-Paletten (B1208A)	EURO-Paletten (Nach DIN EN 13698-1)
		
<p>As loading aids SPAR prefers the use of the IFCO pallet (Endur E7) with the overall dimensions of 1200 mm x 800 mm. In this rental system, there is no pallet exchange. The empty pallets are collected directly from the regional warehouses by employees of the IFCO company for redistribution.</p>	<p>As loading aids SPAR also accepts the use of the CHEP Euro pallet (B1208A) with the overall dimensions of 1200 mm x 800 mm. In this rental system, there is no pallet exchange. The empty pallets are collected directly from the regional warehouses by employees of the CHEP company for redistribution.</p>	<p>As a further loading aid SPAR accepts the Europool Pallet (DIN EN 13698-1). They are processed as described below (Pallet and Poolcase Processing). Generally the pallets and poolcases are processed by exchange. This means that the supplier receives the same amount of exchanged pallets/poolcases as those delivered. One-way, Düsseldorfer and Overseas pallets are not exchanged.* Pallets will always be traded upon delivery of goods (1 to 1 trade)!</p>

SPAR does not accept other loading aids. If the loading aid does not comply with the above-mentioned loading aid, SPAR will charge the supplier for the costs incurred for changing the loading aid (EUR 20.- per pallet).

*Exceptions to the Rule:

- Should there, in exceptional cases, not be enough empty pallets/poolcases for an exchange with the supplier, SPAR will retain the pallets/poolcases as a gratuitous loan from the supplier. The truck driver will receive a confirmation with which the reclaim can be asserted. Reclaiming pallets/poolcases is possible at any time during the following three months as soon as the original confirmation is produced. This rule is only applicable at the relevant Regional Warehouse.
- For reasons of accounting and stock keeping confirmations older than three months can not be redeemed. The possibility to reclaim will expire after three months.
- Should the exchange not be possible on the part of SPAR, the confirmation will be extended for further three months.

3.2 Pallet Quality

SPAR will not accept or exchange pallets on which:

1. a board is missing, or broken either diagonally or straight across
2. a base or decking is so damaged or splintered that a nail or a screw is projecting
3. a block is missing or broken or so splintered that screws or nails are visible.
4. there is not at least one identification symbol (EUR and pool-keeper logo) on each long side that is legible.
5. the general condition is so bad that the load - bearing capacity is not guaranteed or where the loaded goods could be damaged or soiled.

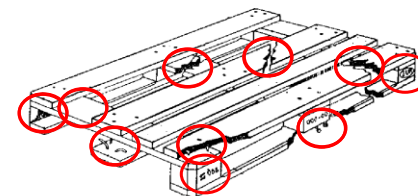

Attention:

An optimal quality of pallets enables an efficient flow of goods in the whole supply chain. In case of a poor pallet quality entry on material-handling equipment is not possible, the risk of breakage is high and goods and in the worst-case consumers can be harmed by wooden splinters, projecting nails and extraordinarily dirty pallets.

Deliveries on poor quality pallets can be rejected by goods receiving, in order to accelerate the goods receiving process.

If the pallets don't meet the SPAR criteria, the supplier will be charged the additional work (EUR 20.- per pallet).

That is also valid for CHEP Pallets, which are distributed over cheaper rental models like the pickup from wholesalers. Such models can lead to a poorer CHEP pallet quality, because of not every pallet being checked and repaired at the CHEP service center. Due to cost and environment reasons this is of course reasonable, but it must not lead to a bad pallet quality. Therefore, every supplier has to check the pallet quality prior to sending, otherwise additional expenses occur in the goods arrival. In case of an accumulation of damaged CHEP pallets we will charge it.

The number of defective pallets and the signature of the goods receiving personnel on the bill of delivery serve as a proof. SPAR has no burden of proof by photographs.

The number of defective pallets and the signature of the goods receiving personnel on the bill of delivery serve as a proof. SPAR has no burden of proof by photographs.

3.3 Pallet Goods-Shifting

No Pallet Shifting Before Transportation

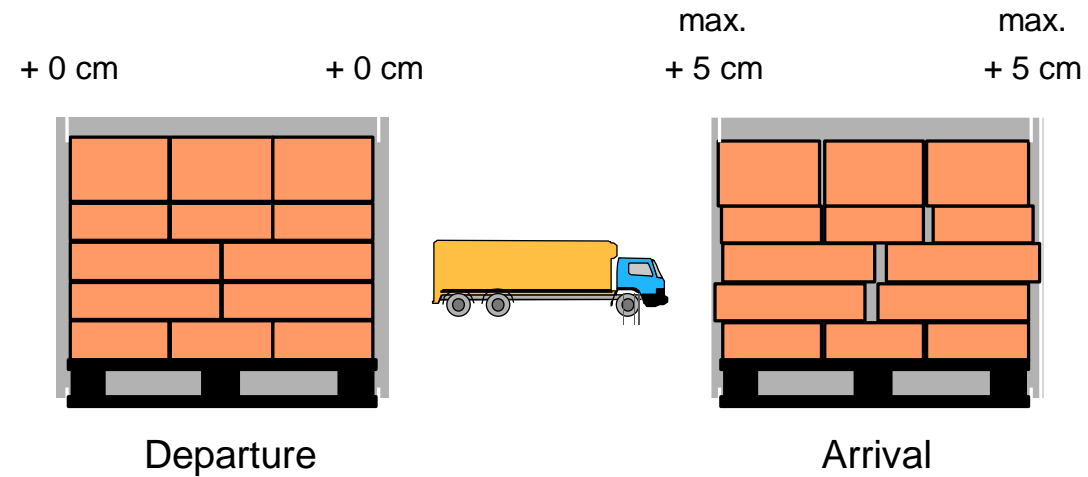

Upon arrival the pallet shifting must not be more than 5cm.

3.4 Pallet Heights

All warehouses are equipped according to EUL pallet heights.

The pallet heights are

ECR-Name	EUL-Overall heights incl. Pallet	
EUL 2	2250 mm	2100 mm product + 150 mm pallet
EUL 1,4	1620 mm	1470 mm product + 150 mm pallet
EUL 1	1200 mm	1050 mm product + 150 mm pallet
EUL ½	675 mm	525 mm product + 150 mm pallet
EUL ⅓	500 mm	350 mm product + 150 mm pallet

3.5 Pallet Weight

The total weight of a pallet may not exceed **1000 kg**.

3.6 Condition of the pallet

- The goods must be stacked as one product per pallet, if the ordered quantity is at least one layer. However, intermediate pallets can be stacked on top of each other.
- Products, in danger of falling off, through transportation by truck, rail or in the warehouse, must be secured with Transport protection (Plastic film or a safety strap). If a plastic film is used, it must not be black.
- All boxes on a pallet must have the same best before date and the same batch number.
- As defined by IFS-Logistics the product safety is a must. That's why a carton must be put between the pallet and goods in easily damageable packaging. This way damaging trough splinters and other sharp items can be avoided and the product safety is guaranteed.

If the condition of the pallet is not conform with the above requirements, SPAR charges the additional expenses of EUR 10,- per pallet.

3.7 Delivery in reusable containers

- SPAR accepts returnable containers (E2 and IFCO). Any new introduction of returnable containers must be announced to SPAR or approved by SPAR.
- **ATTENTION: SPAR only accepts goods from clean containers!**
- Should a delivery be made in unclean containers, the following points apply as a consequence:
 1. Goods will not be accepted or
 2. Goods will be accepted. Then the supplier will be charged EUR 0.50/crate for additional expenses. Should SPAR receive a penalty because of dirty crates, this will be passed on to the supplier.

An exchange of containers takes place as a 1 to 1 exchange upon delivery.

3.8 Condition of the picking unit

- The goods must be in perfect condition. This means no damaged or soiled goods etc.
- The delivery unit must be a closed, compact unit which permits stacking in any position on our roll cages (the goods must not fall out of the packaging).
- The lid may not detach from the carton when lifting (banderols, glue spots, etc.).
- The barcode must be easily found and may not be attached to the lower side of the unit.
- Heavy goods (especially tin cans and glasses) must be shrunk in foil.
- When Shelf Ready Packaging is applied, the unit should be at least as stable for it to permit efficient handling in the warehouse (Glue to stabilise, banderols etc.).
- The size of the wholesale packaging unit (WPU) should be adjusted to the size of the retail packaging unit in order to prevent damage.
- It is not permitted to pack several WPUs in an overpackaging. One unit must be one move.

If the condition of the picking unit is not conform with the above requirements, SPAR charges the additional expenses of EUR 0,5,- per picking unit.



3.9 Delivery note

- For a proper goods arrival in our warehouses SPAR needs a correct delivery paper (delivery note, CMR), on which the SPAR order number must be quoted. For each SPAR order-number a delivery note must be handed over to the bureau of the goods arrival.
- If the SPAR order number is missing on the delivery note/CMR, the delivery note is missing or just placed on the goods or more than one SPAR order number is quoted on the delivery note, SPAR reserves the right to charge the supplier EUR 25,-. A delivery note isn't necessary, if all relevant information is noted on the CMR.

Labelling

Please send us a sample label (pallet and WPU) prior to the first delivery for testing!

In case you are generating a GS1 barcode for the first time, please contact the GS1 institution of your country, to fulfil all requirements.

Warehouse suppliers to:

SPAR Österr. Warenhandels AG

Zweigniederlassung St. Pölten

Lagergasse 30, 3106 St.Pölten-Spratzern

Thomas Gessner, Tel. +43 2742 866 345325

thomas.gessner@spar.at

Additional Information can be found at <http://www.gs1.at>.

Contact GS1

GS1-Austria

Brahmsplatz 3, 1040 Wien

Gerald Gruber, Tel: +43 1 505 8601 43

E-Mail: gruber@gs1.at

4.1 Pallet Labelling

SPAR requires the labelling of all pallets with the GS1-128+SSCC pallet label.

If the GS1:128 and the SSCC are missing or are encoded falsely, SPAR will charge the supplier EUR 5.5 per pallet.

Data Content:

- SSCC - Number of the pallet AI (00)
- the GTIN-Number of the secondary packaging (Wholesale P U) AI (02)*
- the best before date – if available AI (15)
- the batch number – if available AI (10)
- amount of secondary packaging (WPU) on the pallet AI (37)

*The GS1-128+SSCC label must comprise the WPU GTIN which was agreed on with SPAR. Displaying other GTINs, for example the GTIN Number of the over packaging is not permitted.

Module width / Barcode height:

Width: 0,495 – 1,016 mm

Height: 32 mm

Sticker/Label format (Recommendation):

DIN A5 210 x 148 mm (H x W)

DIN A6 148 x 105 mm (H x W)

4.2 Examples of Delivery Notes (DIN A5)

MUSTERUNTERNEHMEN

LOGO

Straße

Ort

Produktbeschreibung

SSCC: **390123450000000012**

CONTENT
(GTIN der Handelseinheit): **9012345000028**

COUNT
(Menge der Handelseinheiten): **120**

BEST BEFORE
(Mindesthaltbarkeitsdatum): **21.05.2023**

BATCH/LOT
(Los/Charge): **A12345678**



(02)09012345000028(15)230521(37)0120



(00)390123450000000012(10)A12345678

4.3 Placement of the pallet labels

- According to the ECR handbook, the GS1 transport-label must be applied 400 - 800mm from the floor and at least 50 mm from the side. On transport secured pallets the sticker must be attached to the plastic film. One label must be applied on the narrow side and one on the long side to the right hand side of it.
- For better processing in our warehouses, we would like to ask you to attach the pallet label as far right as possible. This allows us an optimal handling at every move of the pallet.
- On low pallets it is allowed to bend the text field over the edge onto the top. The barcode part must be scan able without any further manipulation (ECR documentation „Harmonisierung GS1-128 – GS1 Transportetikett“).

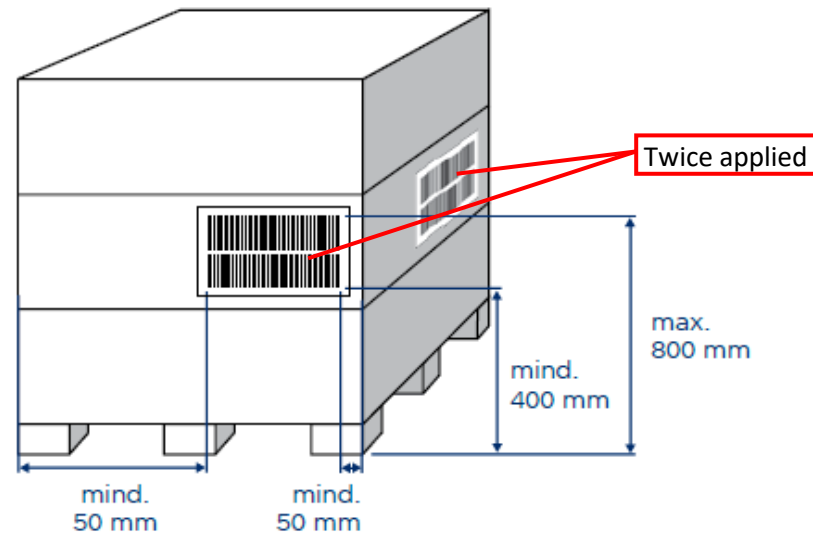

4.4 Product Labelling

WPU (Wholesale-Packing-Unit)

- The secondary packaging should always include a GS1-128 label. The content must be clearly and visibly stated. This facilitates the allocation of the goods to the bill of delivery.
- The contents must be clearly legible visually in order to establish a link to the delivery bill. For this purpose, the article number, the designation and the number of LUs/GVEs must be indicated in clear text.
- The labeling must be in accordance with the GS1 standard on two side surfaces of the packaging.
- In case of missing or wrong labeling of the cartons with EAN-13, ITF-14 or GS1-128 SPAR reserves the right to charge EUR 0.40 per carton to the concerned suppliers. Translated with www.DeepL.com/Translator (free version)

The following topics are important for proper labelling.

- Datafields equal weight products

Name	AI	Datafield	Digits	Example
GTIN of PU	01	n14	16	(01)09012345 67890 9
Best Before Date	15	n6	8	(15)971231
Batch	10	an..20	i.e. 6	(10)1234

- Datafields random weight products

Name	AI	Datafield	Digits	Example
GTIN of PU	01	n14	16	(01)99012345 67890 9
Best Before Date	15	n6	8	(15)971231
Weight	3100 - 3103	n6	10	(3103)048000
Batch	10	an..20	i.e. 6	(10)1234

4.4 Product Labelling

Random weight products – equal weight products

We differ between random-weight products and equal-weight products. Random-weight products fluctuate in their product weight and are billed by weight. The barcode of these products has to include the product weight. The 14 digit GTIN Article number of equal-weight products starts with a 0 - 8, that of random-products items starts with a 9.

Ways of attaching the GS1-128 label to the WPU

- Carton and foil packaging: attachment on top, outside the packaging
- Bar of Cheese/Cold Cut: attachment lengthwise on the packaging
- Other One-way packaging: attachment on side or on the front of the case/carton

Ways of attaching the GS1-128 label to a reusable case

- Attachment on case itself (label must be easy to remove).



Should the labelling according to GS1-128 standards be missing or be encoded falsely, SPAR will charge the supplier a surcharge of EUR 0.40 per unit.

4.5 RPU (Retail Packing Unit)

Labelling with the following barcode is accepted:

- EAN-8
- EAN-13
- UPC-A

Examples of labels:

 9 0 9 9 9 1 2 3	 9 0 1 2 3 4 5 0 0 0 0 1 1 >	 0 1 2 3 4 5 6 7 8 9 1 2
EAN-8	EAN-13	UPC-A

4.6 Barcode quality

In order to ensure fast and efficient scanning processes at the cash registers and in SPAR wholesale-fulfillment centers, the following quality requirements of the barcodes are needed:

The attached bar code symbol must have at least the following overall symbol class according to **ISO / IEC 15416**:

The attached barcodes must have an overall symbol class of at least **1.5** according to ISO / IEC 15416 (test specification for barcode quality), the barcode must also correspond to the respective specifications of the barcode symbology.

To ensure optimal readability of the barcodes, SPAR recommends an overall symbol **classification of 2.5**.

For your information: A barcode can be rated between 0 and 4 with a test device. According to ISO / IEC 15416 a rating of 4 is the best value. The check can be carried out by an GS1 organization such as GS1 Austria (www.gs1.at/stichcodepruefservice).

Electronic Data Interchange with SPAR

SPAR provides the possibility of interchanging data electronically. The supported messages are orders, Despatch Advice (for warehouses and direct deliveries) and Invoic.

In our Warehouses we set a high value into the DesAdv. This electronic message enables precise planning and processing at the goods receiving and thus accelerates the process. This results in shorter waiting times.

Therefore, we expect our partners to transmit electronic bills of deliveries which accord to todays standards.

BEWARE! In order to use DesAdv's, the correct use of the GS1-128 label on the pallets is absolutely necessary.

Information on the composition of Despatch Advices can be found on our B2B Portal using the following [Link](#) or by accessing threwh the B2B-portal (<http://b2b.spar.at>).

In the Warehouses we require the hierarchical DesAdv incl. SSCC.

If the transferred data (expiry date, quantity and batch) from the DesAdv is not correct or the whole DesAdv is missing, SPAR charges the additional expenses of EUR 100,-.

Safety measurements at Goods Receiving

Warehouse Premises

- Driving with an open auto hoist on SPAR warehouse premises is forbidden.
- The road transport regulation is applicable on warehouse premises, with a maximum speed of 10 km/h and keeping to the right. Please beware of human traffic.
- The parking of vehicles is only permitted in the designated areas and only until unloading.

Goods receiving

- Follow the instructions of the goods receiving personnel.
- Access is only granted to the goods receiving area. All other areas of the warehouse may only be accessed when permitted.
- Before unloading the supplier has to register with the responsible goods receiving and show bill of lading and bill of delivery.
- The automatic lifting ramps are to be operated accordingly. Should the truck driver have no experience with these he must announce this to the SPAR personnel who will brief him.
- The unloading has to be carried out by the supplier.
- The unloading is only permitted with safety shoes.
- Should the pallet quality not comply with the standards of SPAR, the pallet will not be exchanged.



Safety measurements at Goods Receiving

General

- The handling of SPAR owned electronic devices takes place at the users' risk. The supplier is liable for all damage occurred. Accidents and damage are to be announced to the goods receiving supervisor immediately and a report of the accident has to be written.
- All waste has to be removed accordingly.
- Smoking in the hall and the drinking of alcoholic beverages everywhere on the warehouse premises are strictly forbidden.
- Beware of frequent traffic with electronic devices at goods receiving.
- In case of a fire alarm, obey the instructions of SPAR personnel.
- Emergency exits have to be free at every time.

